

Höhenausgleich DuraLift

- Höhenausgleich 6mm - 50mm
- Belastbar bis 500 kg pro m²
- Auch von oben verstellbar (Dielenspalt)

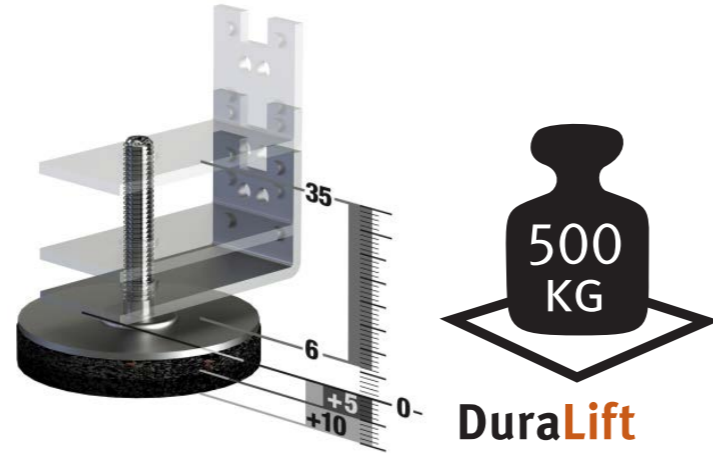

Das Fundament für Generationen

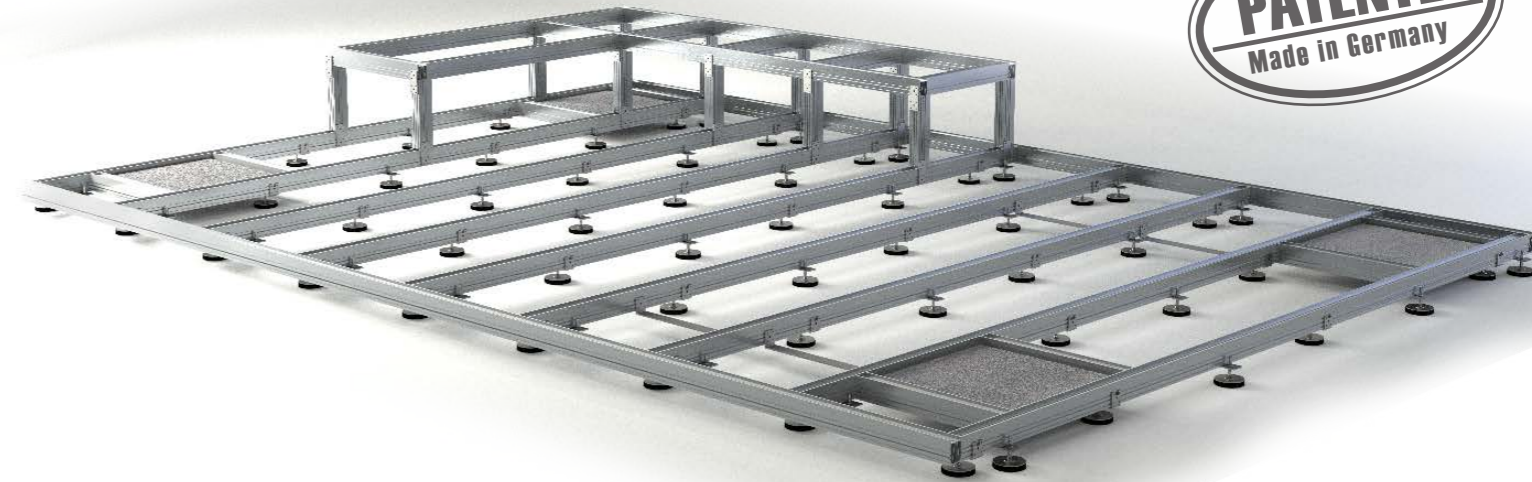

Flach- und Winkelverbinder DuraFix

- zur Aufdopplung von Profilen, zur Erhöhung der Stabilität
- vielfältige Montagekombinationen auch in die dritte Dimension
- für einen Stirnstoß
- alle DURABEAM Versionen sind untereinander kombinierbar

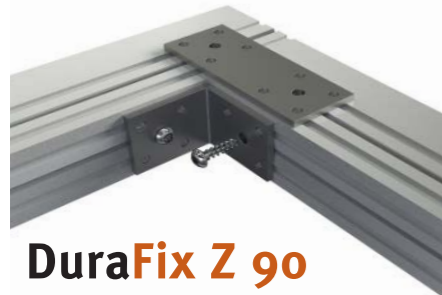

DuraFix
Z 180



Varioverbinder DuraFix Z Vario

- variables Verbindungsstück zur Anpassung der UK an beliebig verlaufende Winkel auf der Baustelle



DuraFix
Z Vario



Ein Produktvideo und die Montageanleitung können wir Ihnen bei Bedarf gerne zukommen lassen.



Joh. Heinrich Warncke GmbH

SOLUMTERRASSENDIELEN

Schauenburger Str. 9 · 25421 Pinneberg
Tel. 04101 / 54 59 0 · Fax. 04101 / 54 59 99 · info@warncke-online.de

Am Birkfeld 22 · 86453 Dasing
Tel. 08205 / 95 95 10 · Fax. 08205 / 95 95 120 · info@warncke-online.de

Erhältlich bei



Große Einsatzvielfalt...

Profilverlängerung



Varioverbindung



Winkelverbindung



Ballastaufnahme



Verblendfixierung



Winkelverstärkung

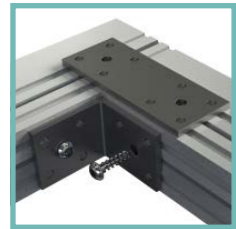

DuraFix Z 180



DuraFix Z 90



UK-Höhenregulierung



Aufdopplung

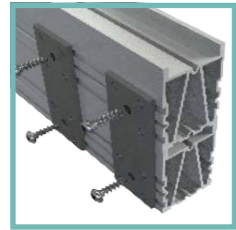

DuraFix Z Vario



DuraFlip



DuraLift



DuraClip Z 1

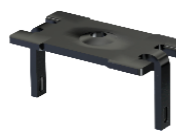

DuraClip Z 2

Flexibler Bohlenclip



Stirnstoß

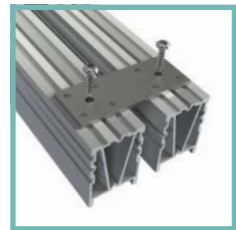

Revisionselement

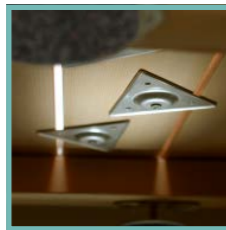

Problemlos in die 3. Dimension

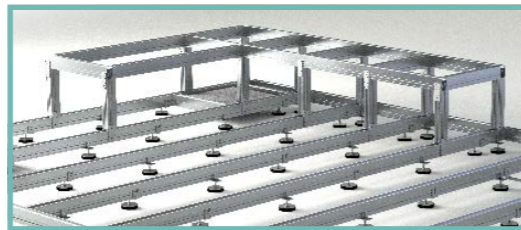

Flexible Randklammer



Warum REIF ■ DuraLink® ?



- Langlebiges System
- Einfache & zeitsparende Verlegung
- Keine Metallspäne
- Einsatz in der 3. Dimension
- Flexibel in der Anwendung
- Formschlüssige Verbindung
- Für alle gängigen Terrassendielen
- Made in Germany

DuraBeam – das Aluminiumprofil



- Hochstabilen Aluminium-Profil für die Terrassen-Unterkonstruktion
- Konstruktiver Nässechutz
- Doppelte Innenverstrebung für hohe Festigkeit
- Führungsnuten als flexible Aufnahme für DuraFix-Verbinder

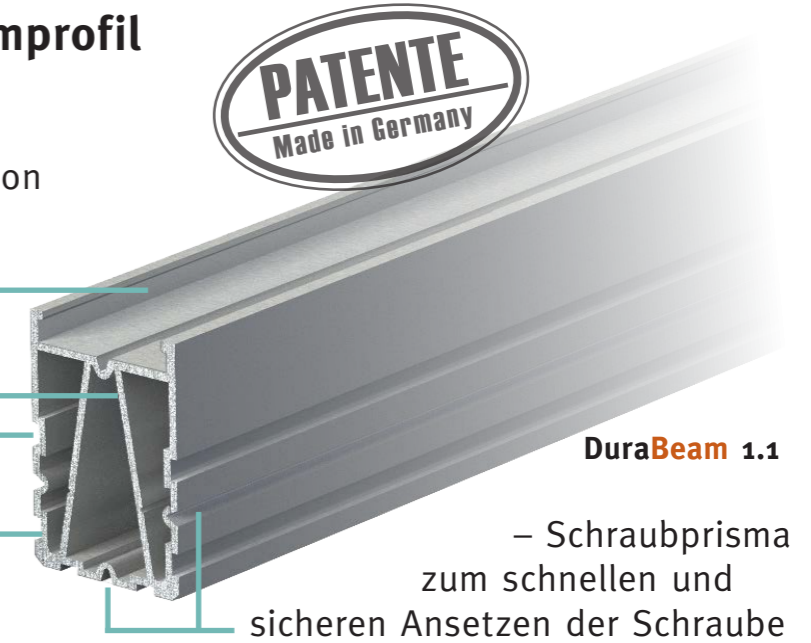

DuraBeam 1.1

- Schraubprisma zum schnellen und sicheren Ansetzen der Schraube



DuraBeam 1.1

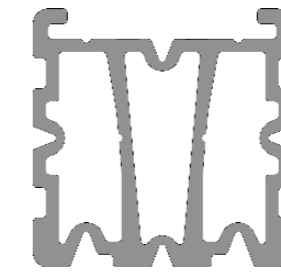

DuraBeam 3.0

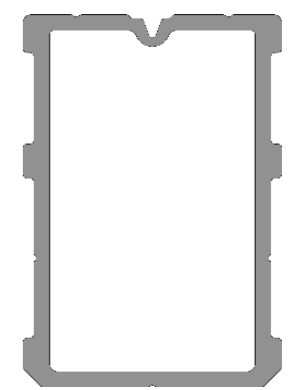

DuraBeam 5.0

DuraBeam – das Schraubprisma

- Einschrauben mit einer Blechschraube ohne Spanbildung
- Sicheres Ansetzen der Schraube
- Schnelles und leichtes Eindrehen der Schraube
- Von 4 Seiten verschraubbar
- Materialverdrängung statt Zerspanung! **KEINE Metallspäne!**

